

Suministros Cerrajeros Miño

SUCERMIÑO, S.L.

CATÁLOGO

2016

PERFILES ALUMINIO CANCELAS









Ver páginas 38-39 para montaje.

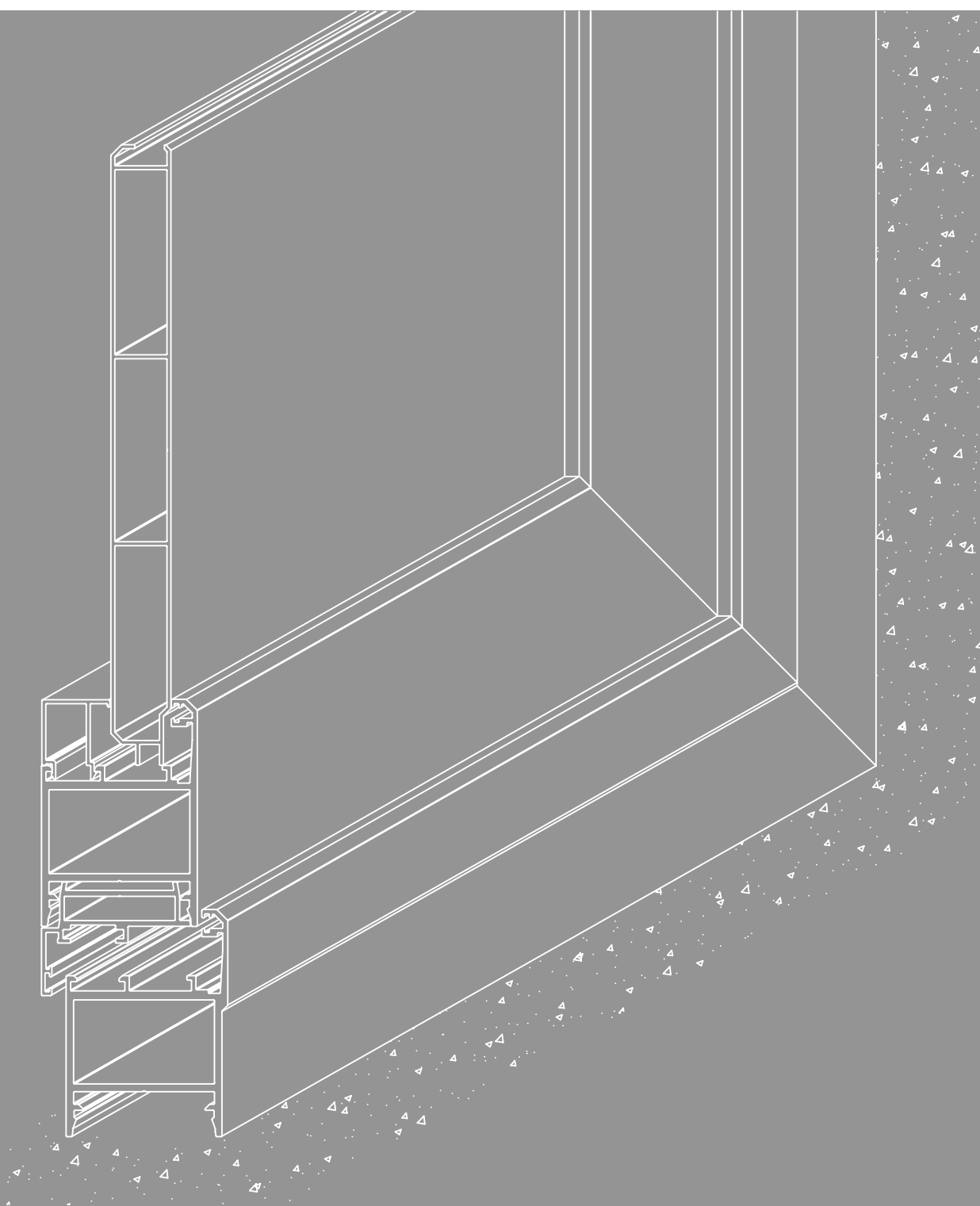



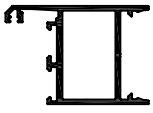
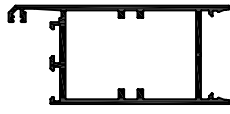
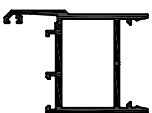
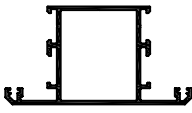
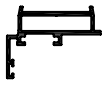
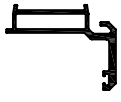

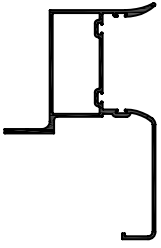
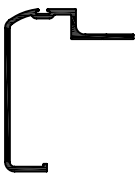

01

CANCELAS





LISTA DE PERFILES

DISEÑO	REFERENCIA	DESCRIPCIÓN	CÓDIGO
	11001	<i>Hoja pequeña</i>	APT 001
	11002	<i>Hoja grande</i>	APT 002
	11003	<i>Marco Fijo —</i>	APT 003
	11004	<i>Travesaño</i>	APT 004
	11005	<i>Batiente CE</i>	APT 005
	11006	<i>Batiente</i>	APT 006
	11007	<i>Perfil de remate U</i>	APT 007
	11008	<i>Tapa</i>	APT 008
	11010	<i>Batiente de cierre corredera</i>	APT 010
	11011	<i>Remate de paso corredera</i>	APT 011
	11012	<i>Guía corredera</i>	APT 012

DISEÑO	REFERENCIA	DESCRIPCIÓN	CÓDIGO
	11017 11023	<i>Junquillo 17mm</i> <i>Junquillo 22,7mm</i>	APT 017 APT 023
	11030	<i>Lama asimétrica 200x20</i>	APT 030
	11031	<i>Lama tablón biselado 200x25</i>	APT 031
	11032	<i>Lama para tubo 200x25</i>	APT 032
	11050	<i>Perfil Tope Escuadra</i>	APT 050
	1101718	<i>U Refuerzo fijación motor 60x17</i>	AP 1718
	1102030	<i>Lama 100x20</i>	TS 2030
	11015020	<i>Lama biselada 150x20</i>	TPT 08

LISTA DE PERFILES

DISEÑO	REFERENCIA	DESCRIPCIÓN	CÓDIGO
	11020020	<i>Lama biselada 200x20</i>	TPT 09
	11035	<i>Lama biselada simétrica 200x25</i>	TPT 035

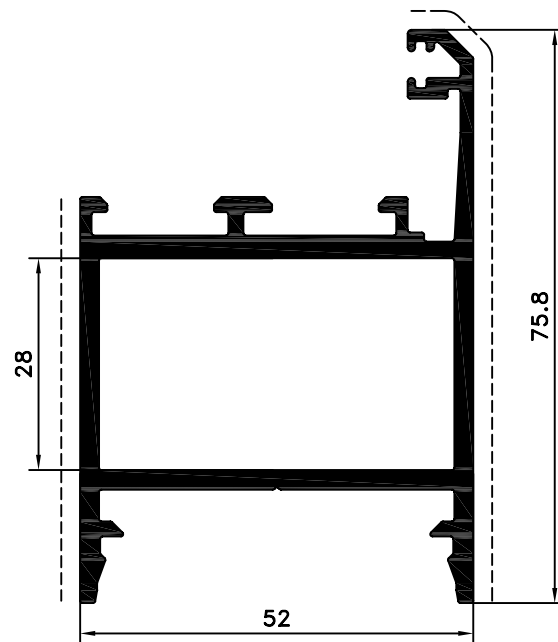

REF. 11001 *Hoja pequeña* APT 001

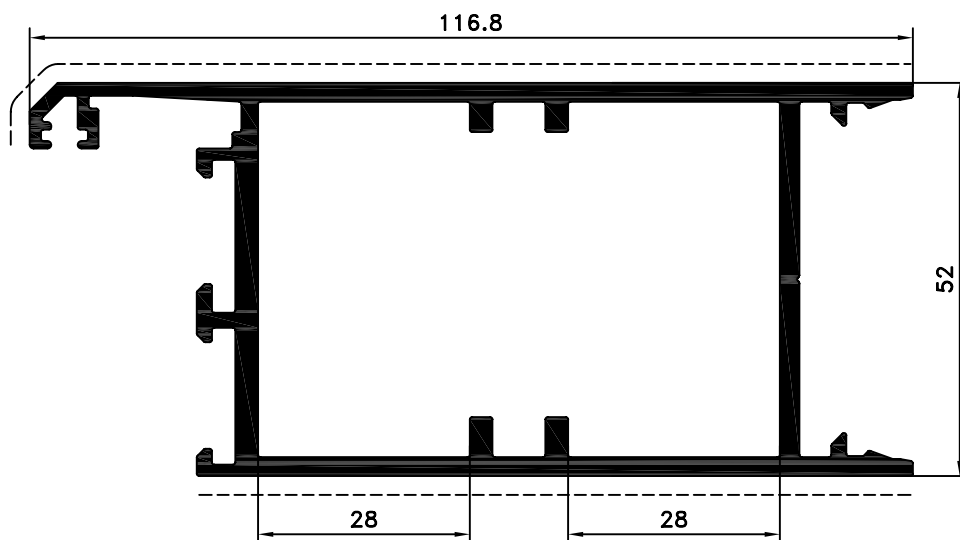

REF. 11002 *Hoja grande* APT 002

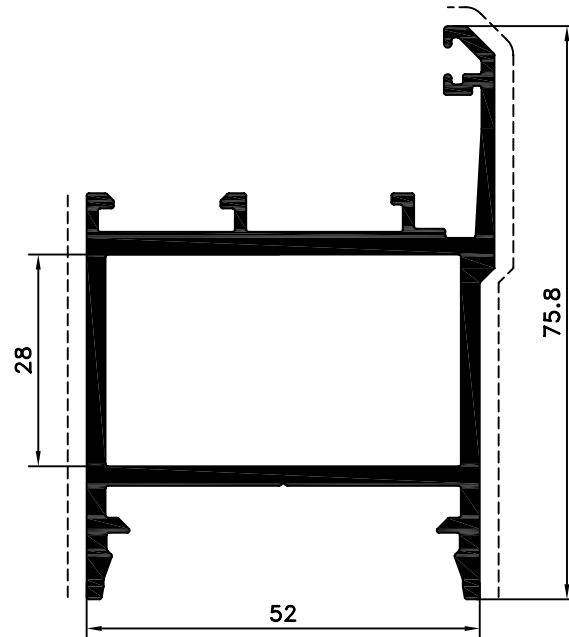

REF. 11003 Marco fijo APT 003

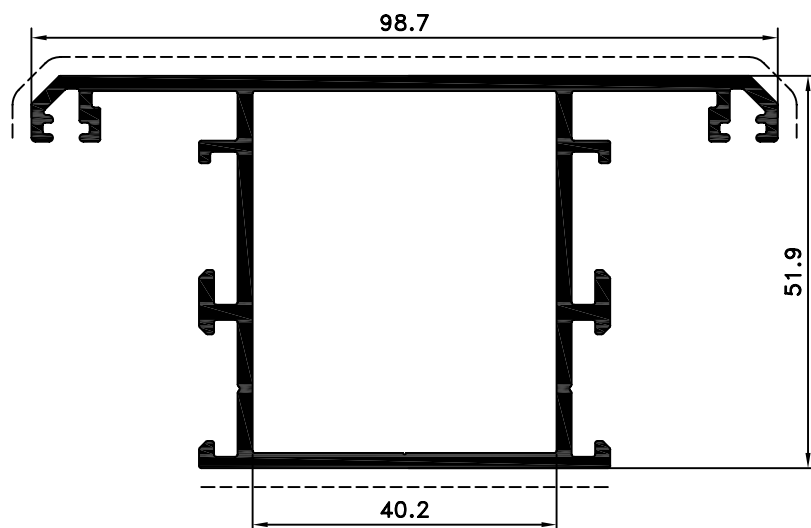

REF. 11004 Travesaño intermedio APT 004

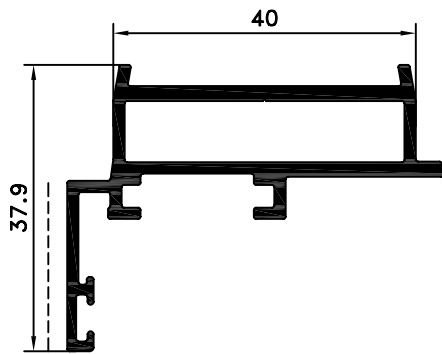

REF. 11005 *Batiente canal europeo* APT 005

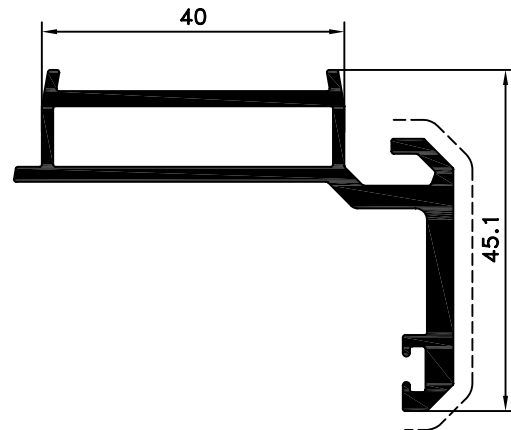

REF. 11006 *Batiente puerta 2 hojas* APT 006

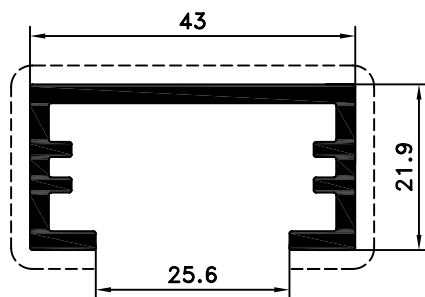

REF. 11007 *Perfil U* APT 007

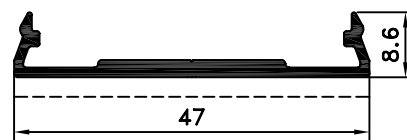

REF. 11008 *Tapa clip* APT 008

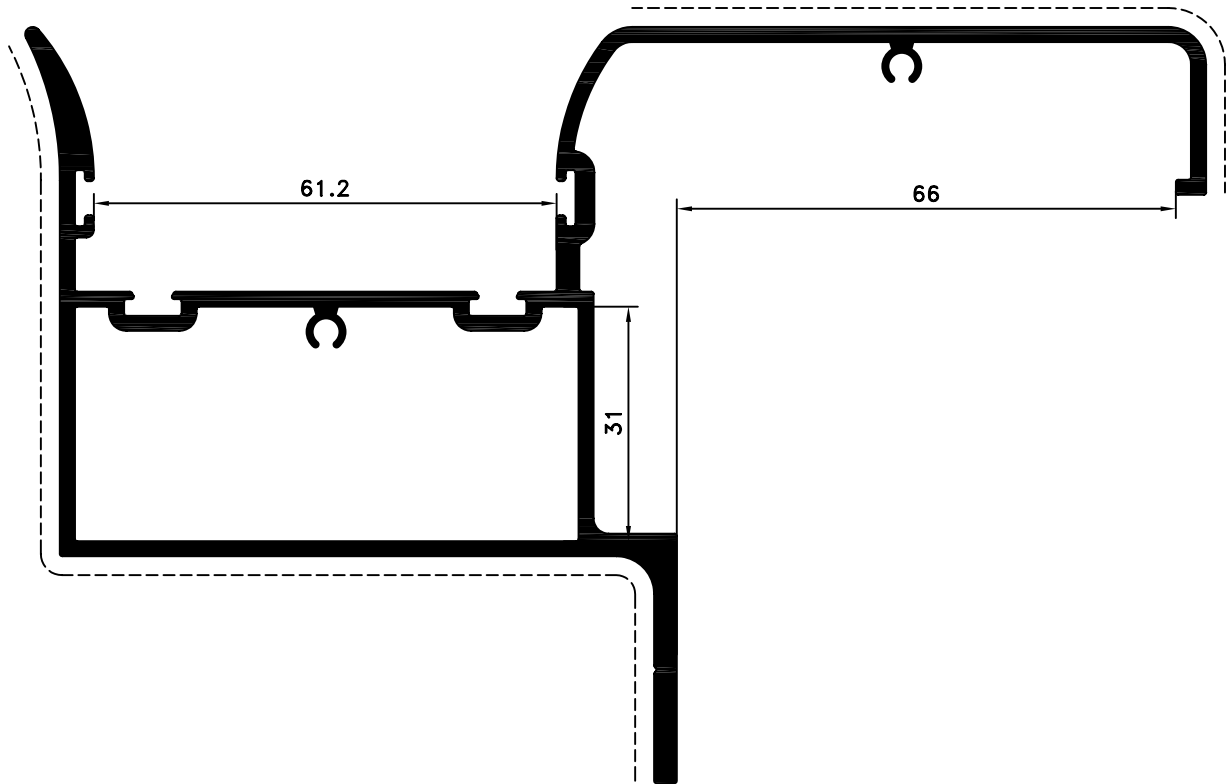

REF. 11010 *Batiente cierre corredera* APT 010

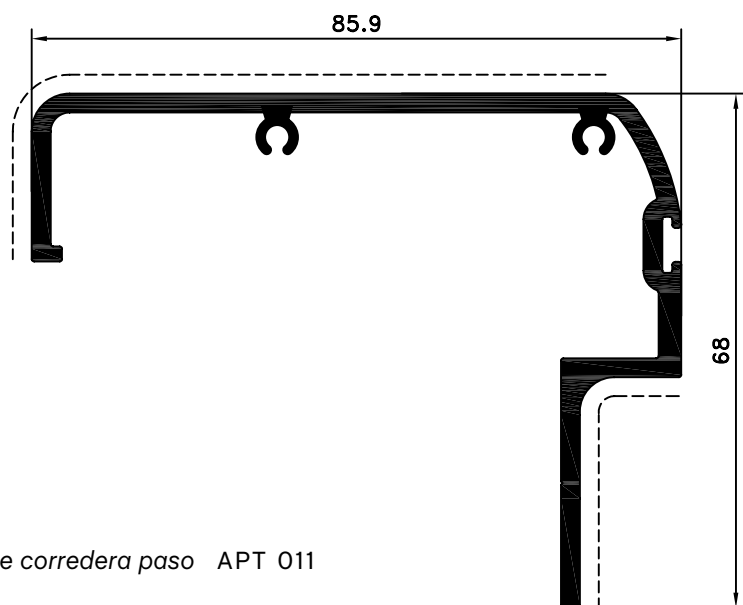

REF. 11011 *Remate corredera paso* APT 011

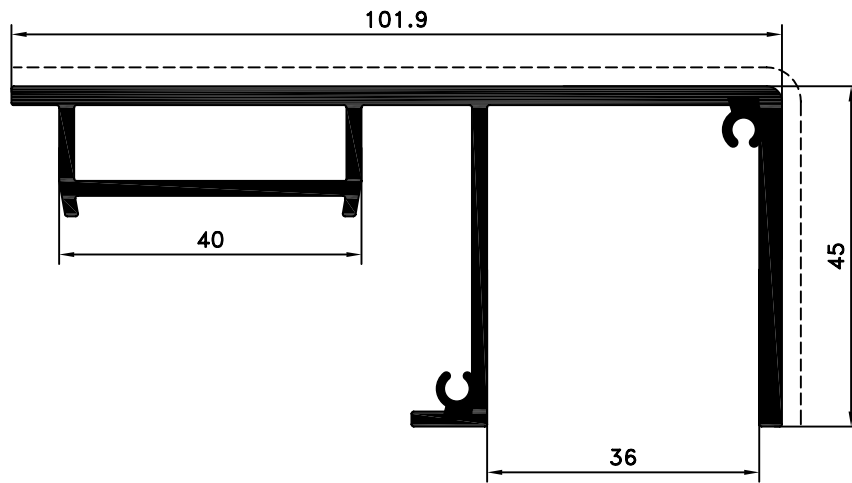

REF. 11012 Perfil superior corredera con guía U APT 012

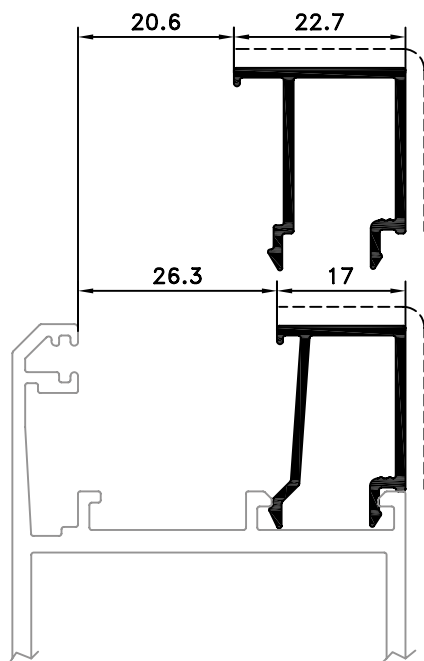

REF. 11023 Junquillo 22,7mm APT 023

REF. 11017 Junquillo 17mm APT 017

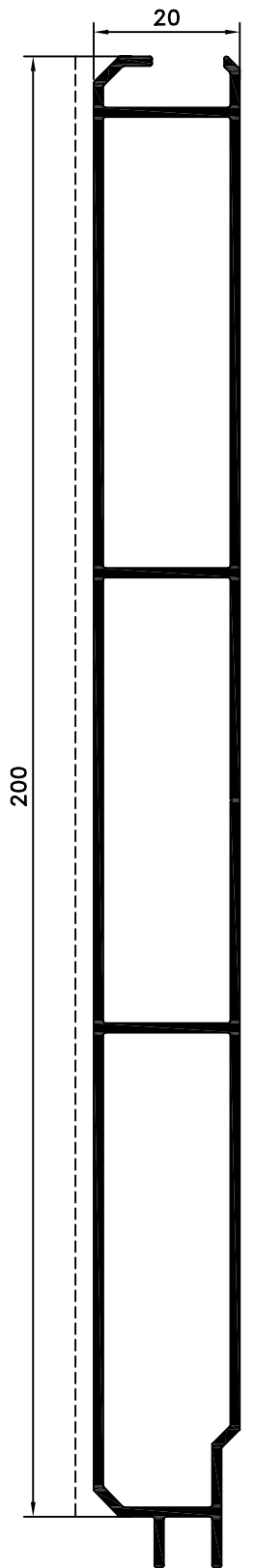

REF. 11030
Lama 200x20 c/ bisel
APT 030

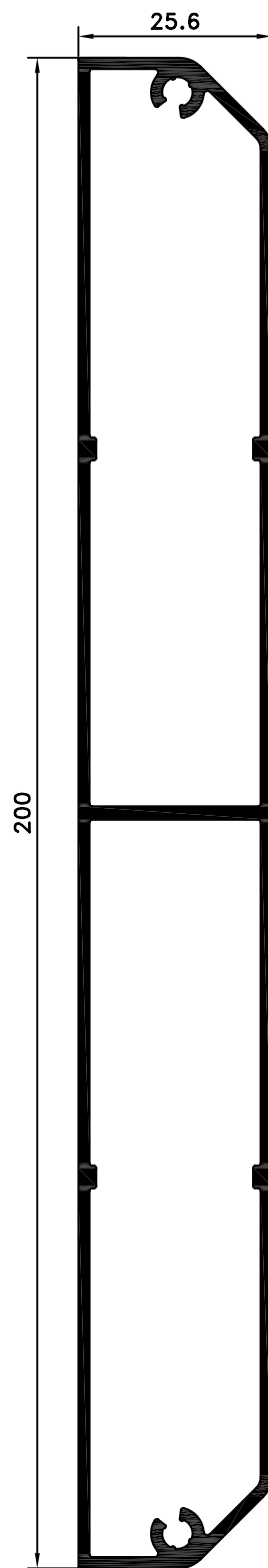

REF. 11031
Lama tablón biselada 200x25,6mm
APT 031

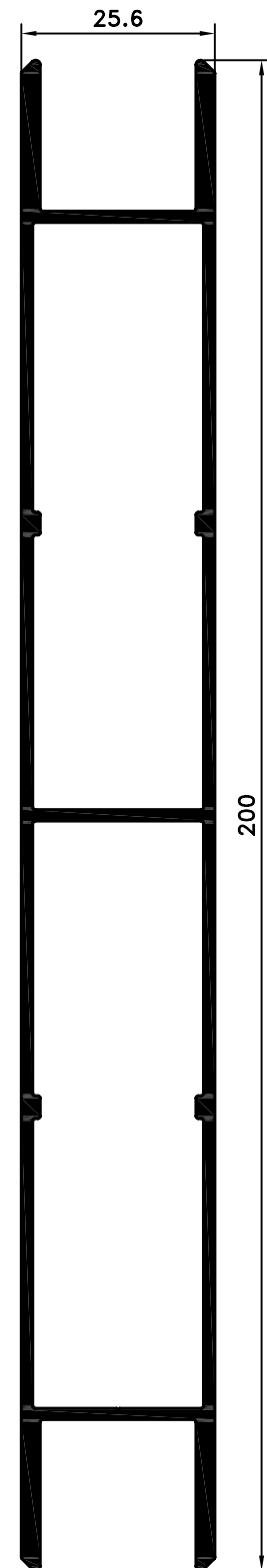

REF. 11032
Lama 200x25,6 p/ tubo 20mm
APT 032

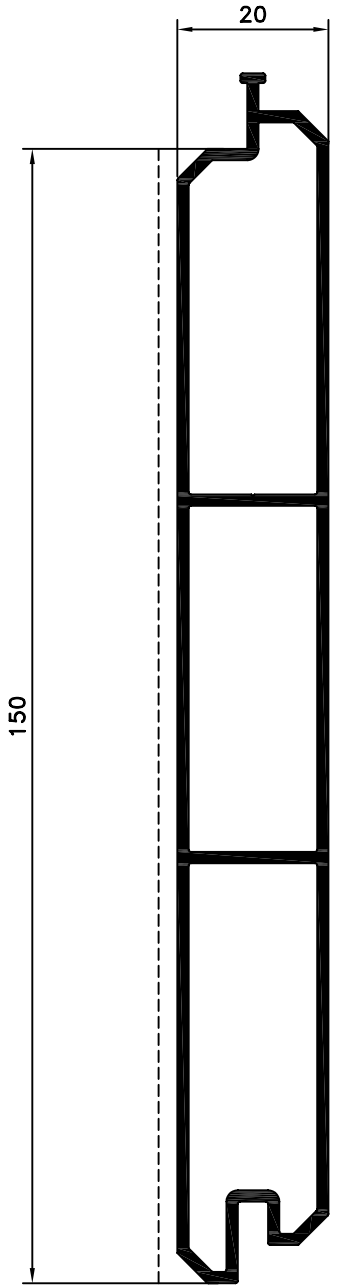

REF. 11015020
Lama biselada 150x20
TPT 08

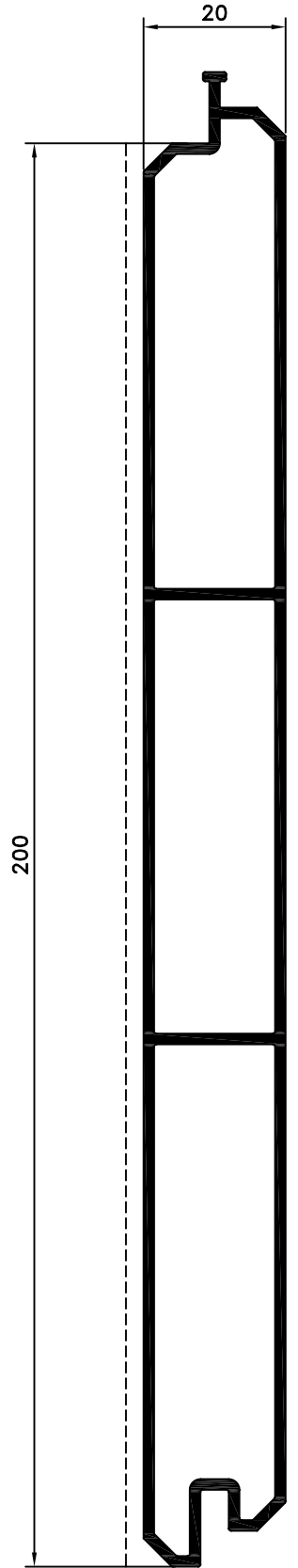

REF. 11020020
Lama biselada 200x20
TPT 09

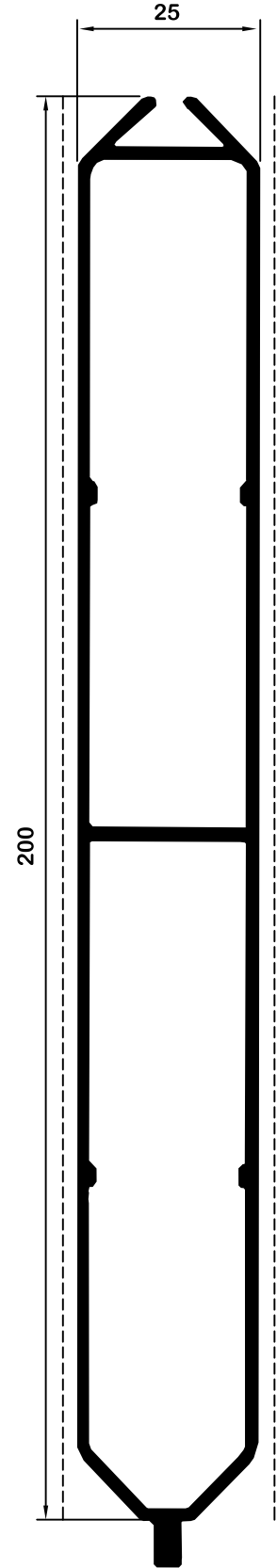

REF. 11035
Lama biselada simétrica 200x25
TPT 035

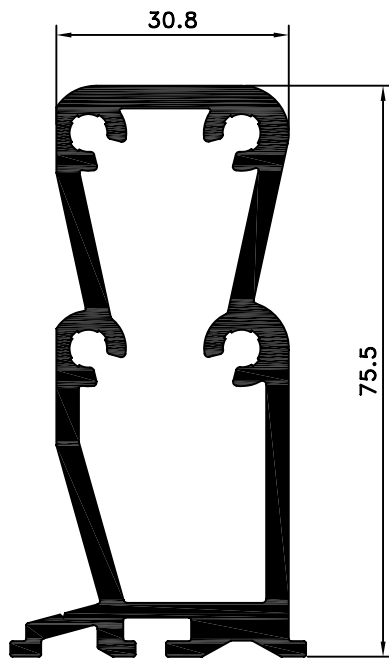

REF. 11050
Perfil tope escuadra
APT 050

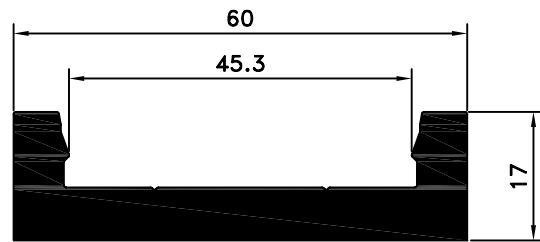

REF. 1101718
U 60x17 refuerzo motor batiente
APT 1718

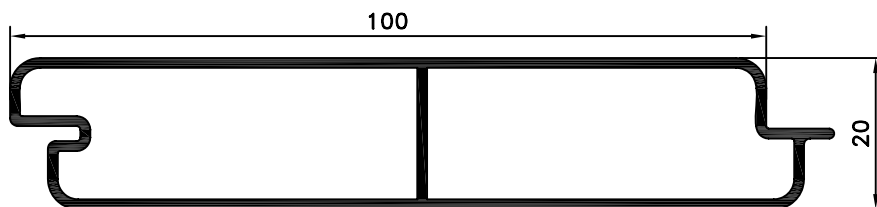

REF. 1102030
Lama 100x20
TS 2030

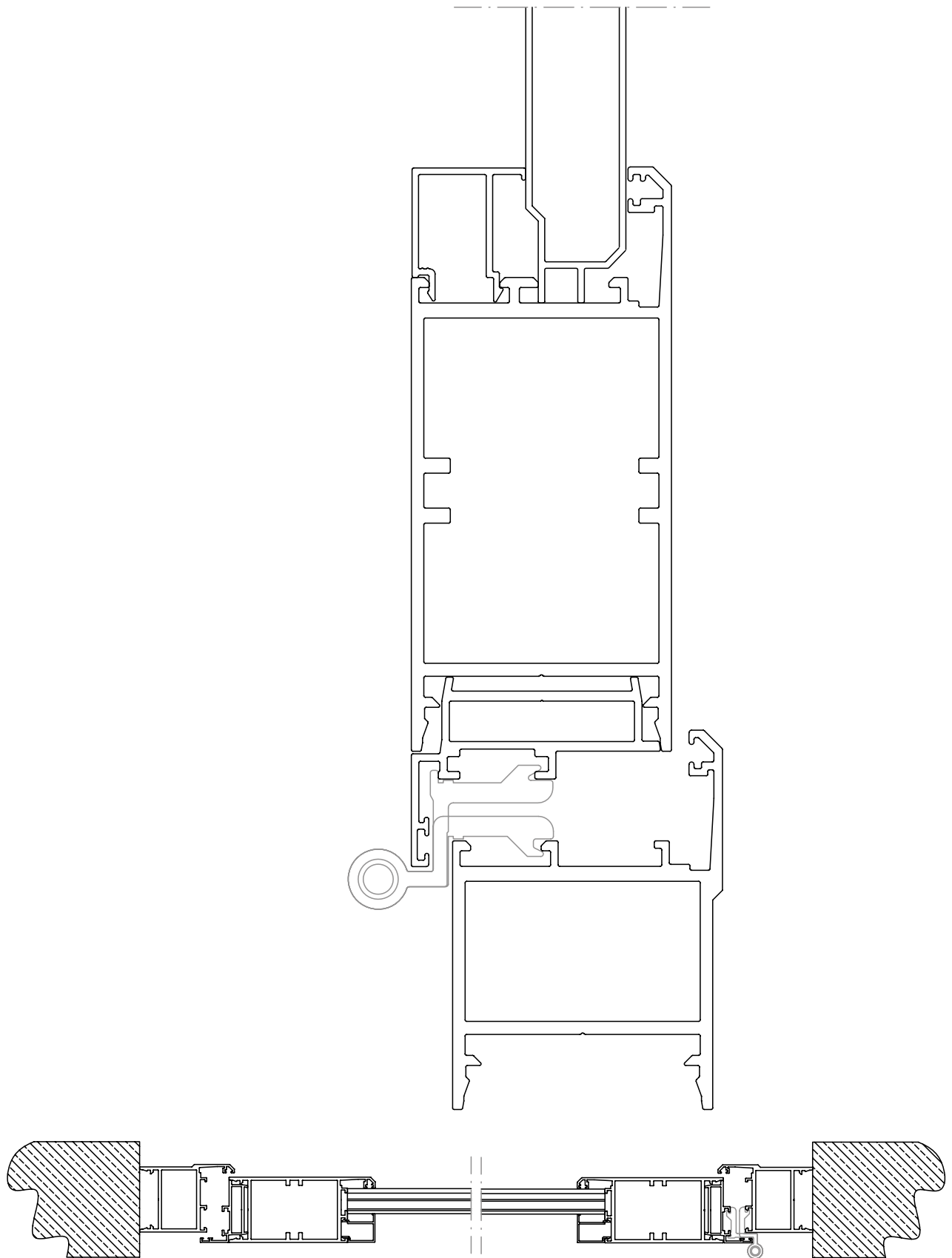

Puerta de paso. Bisagra CE

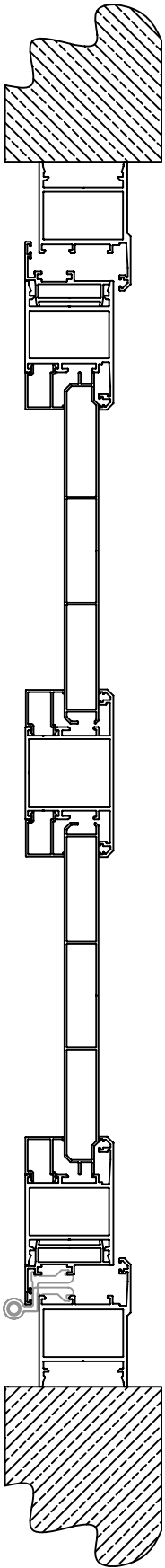

*Puerta de paso.
Bisagra CE. Travesaño interior.*

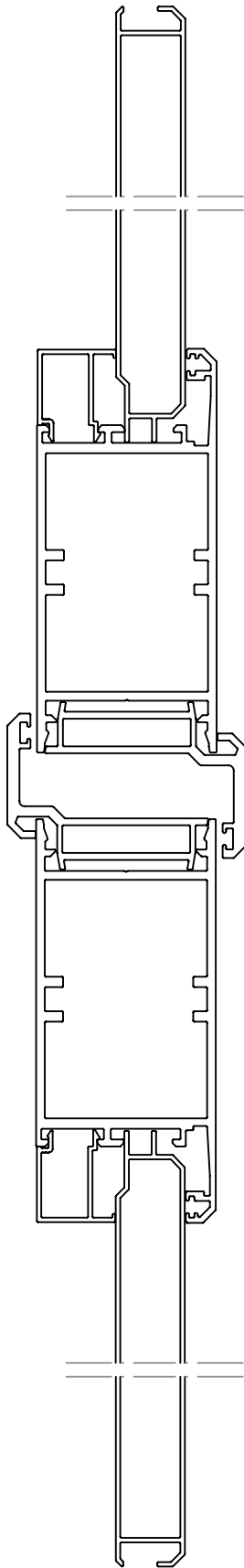

Puerta de 2 hojas abatible.

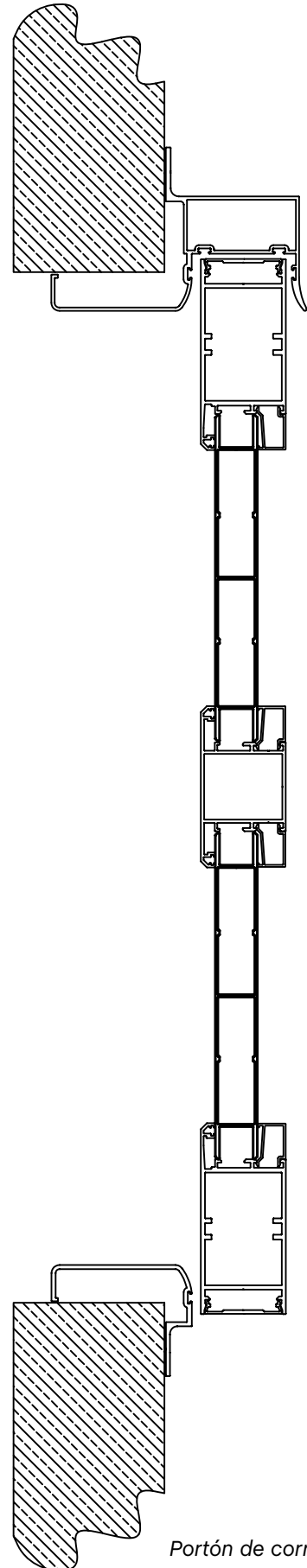

Portón de corredera.

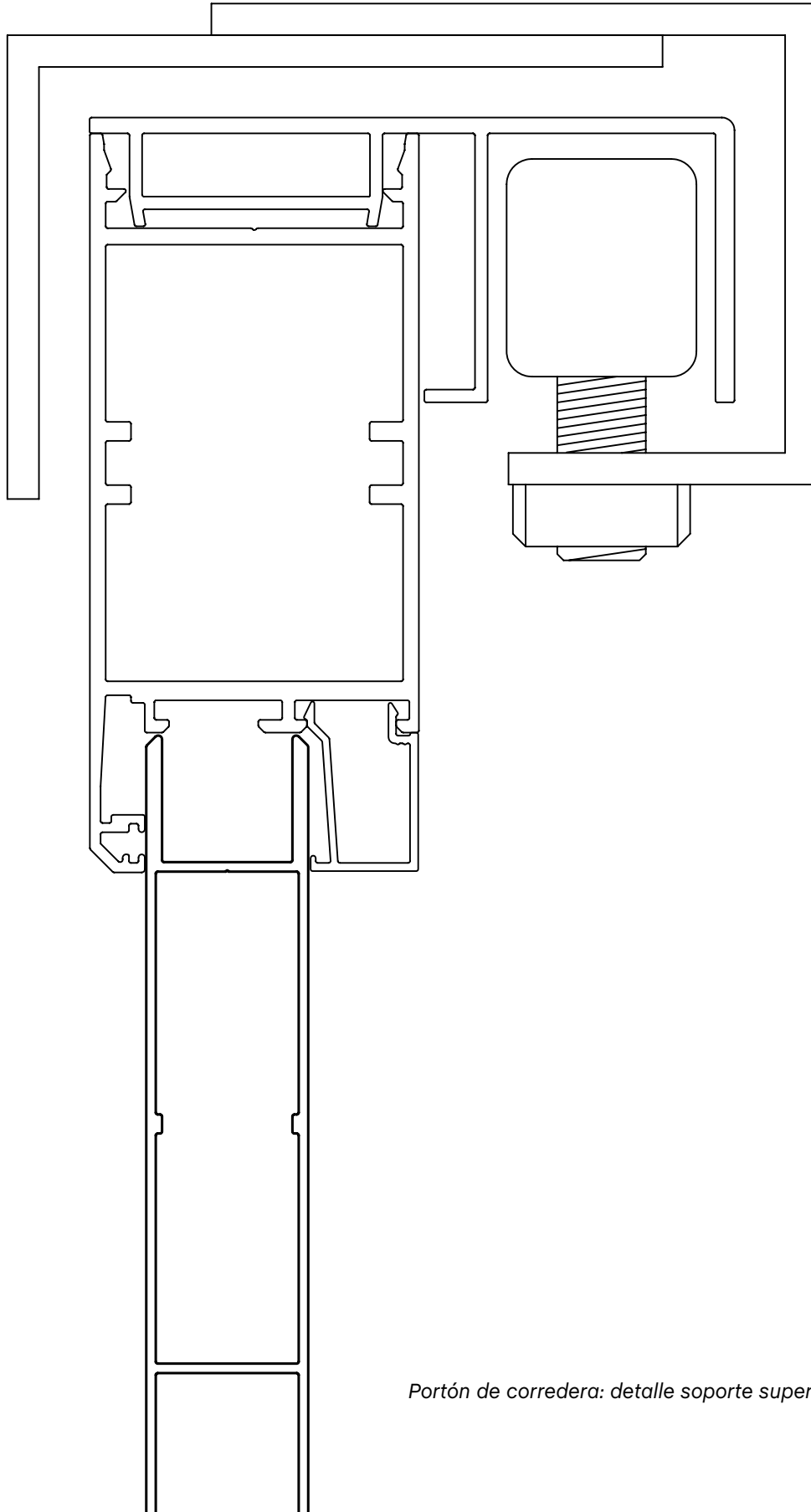





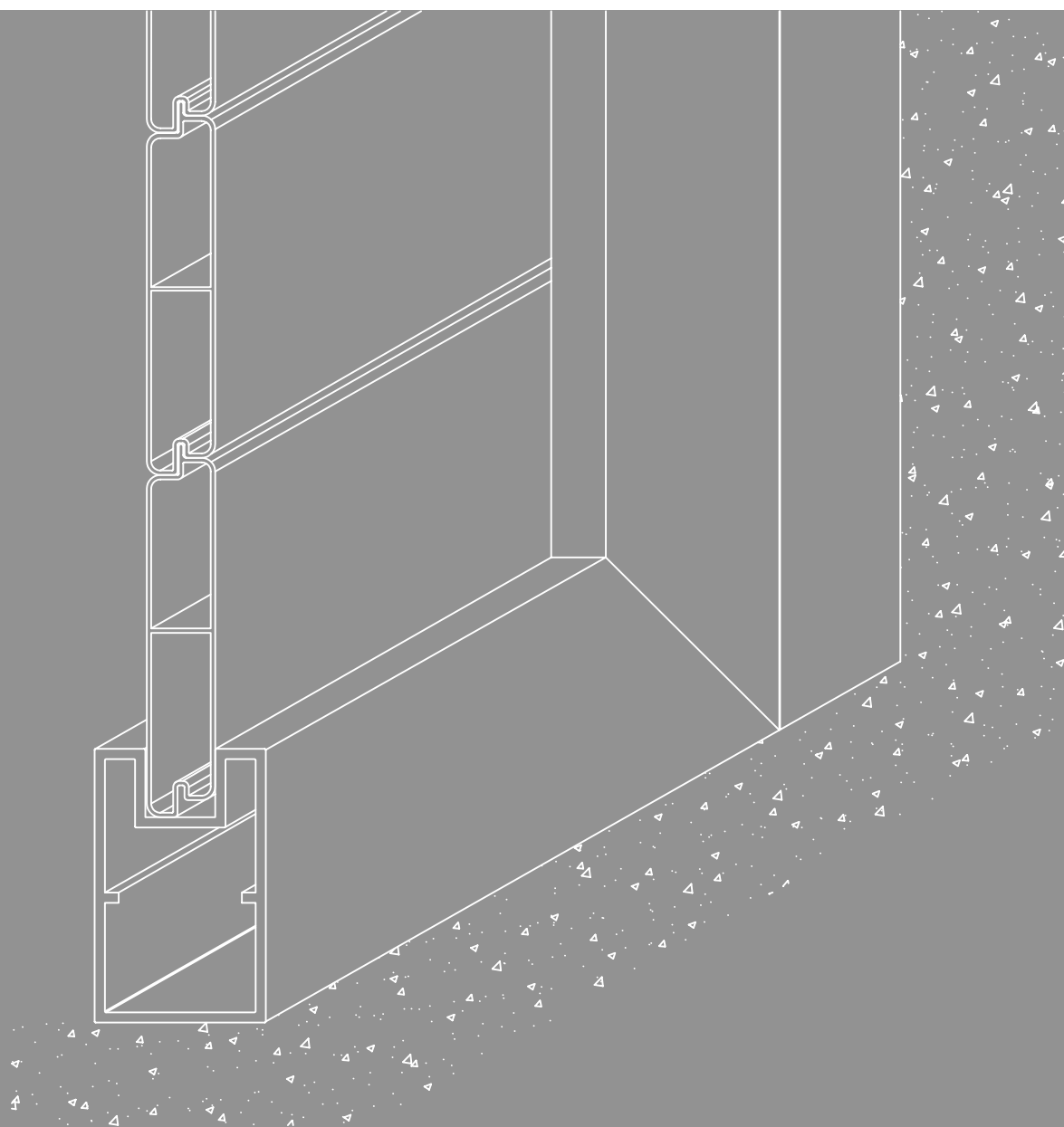

Portón de corredera: detalle soporte superior.

02

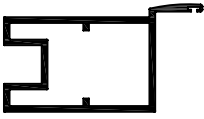
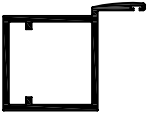
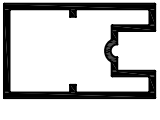
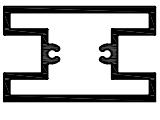
CANCELAS DE SOLDAR



LISTA DE PERFILES

DISEÑO	REFERENCIA	DESCRIPCIÓN	CÓDIGO
	110001	<i>Hoja batiente</i>	TPT 01
	110002	<i>Marco</i>	TPT 02
	110003	<i>Hoja 80x50</i>	TPT 03
	110004	<i>Travesaño 80x50</i>	TPT 04
	1101718	<i>U 60x17</i>	AP 1718
	1102030	<i>Lama 100x20</i>	TS 2030
	11015020	<i>Lama biselada 150x20</i>	TPT 08
	11020020	<i>Lama biselada 200x20</i>	TPT 09
	11035	<i>Lama biselada simétrica 200x20</i>	APT 35

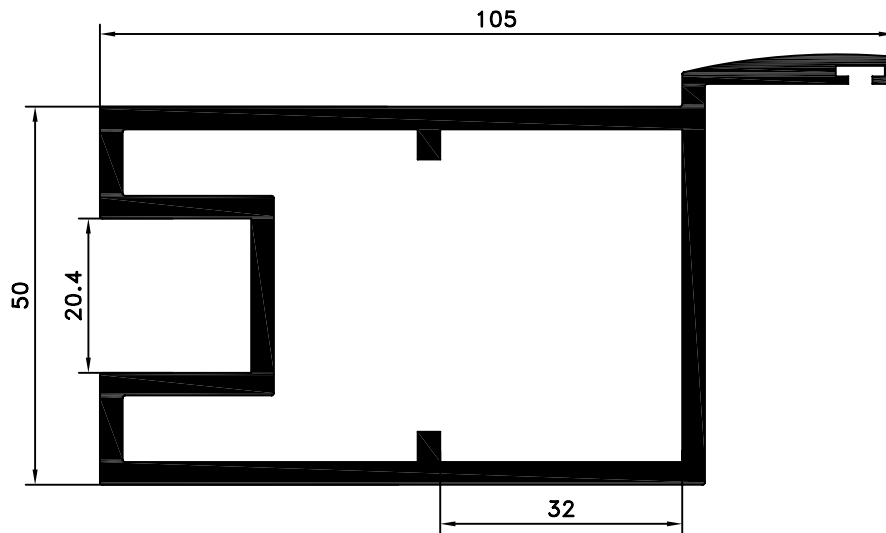

REF. 110001 *Hoja batiente lama 20mm* TPT 01

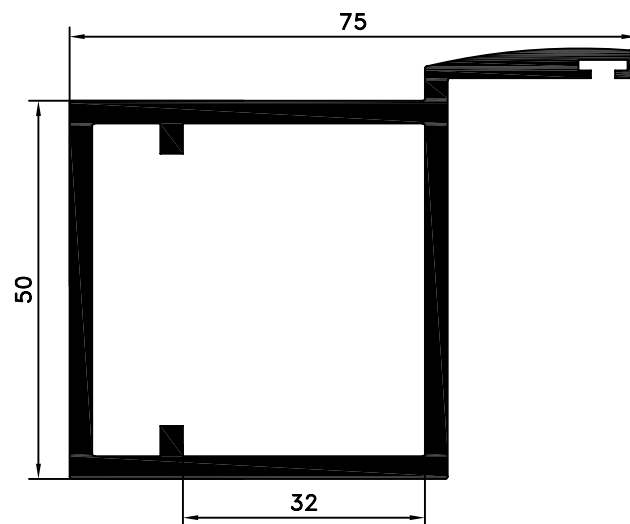

REF. 110002 *Marco* TPT 02

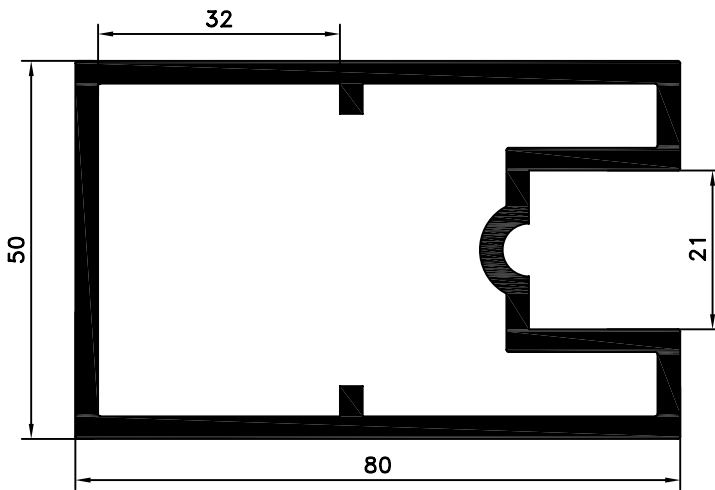

REF. 110003
Hoja lama 20 mm
TPT 03

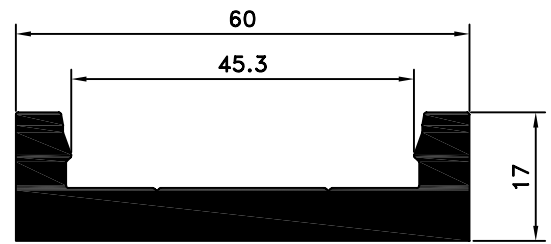

REF. 1101718
U 60x17 refuerzo
AP 1718

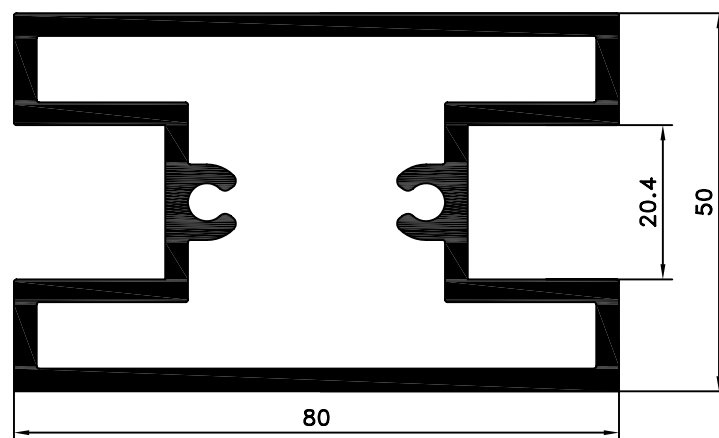

REF. 110004 Travesaño lama 20 mm TPT 04

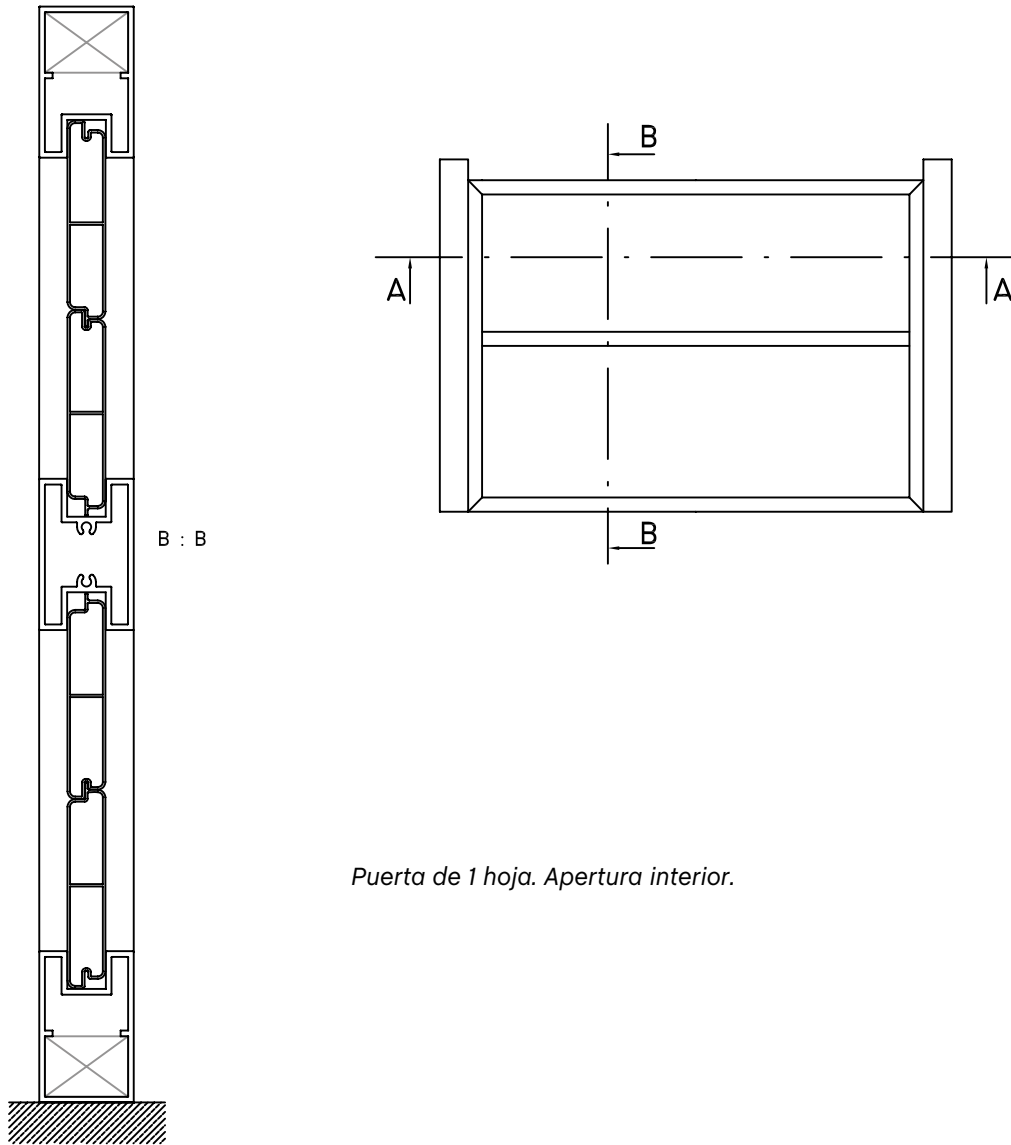

Puerta de 1 hoja. Apertura interior.

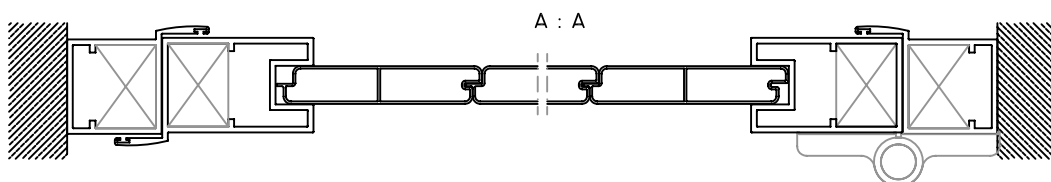

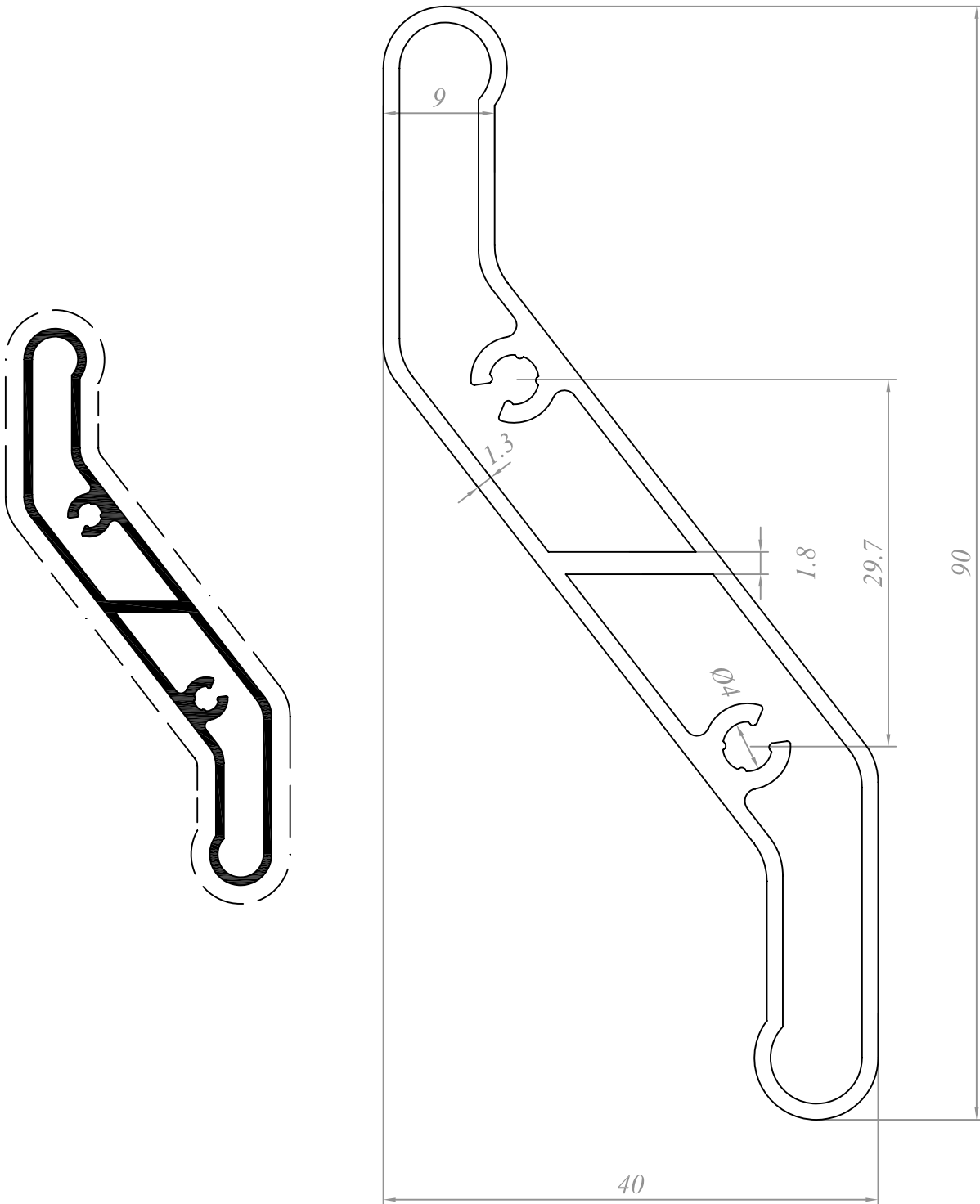

REF. 1102090 Lama ventilada CÓD. TS 2090

03

PERFILES ESTÁNDAR

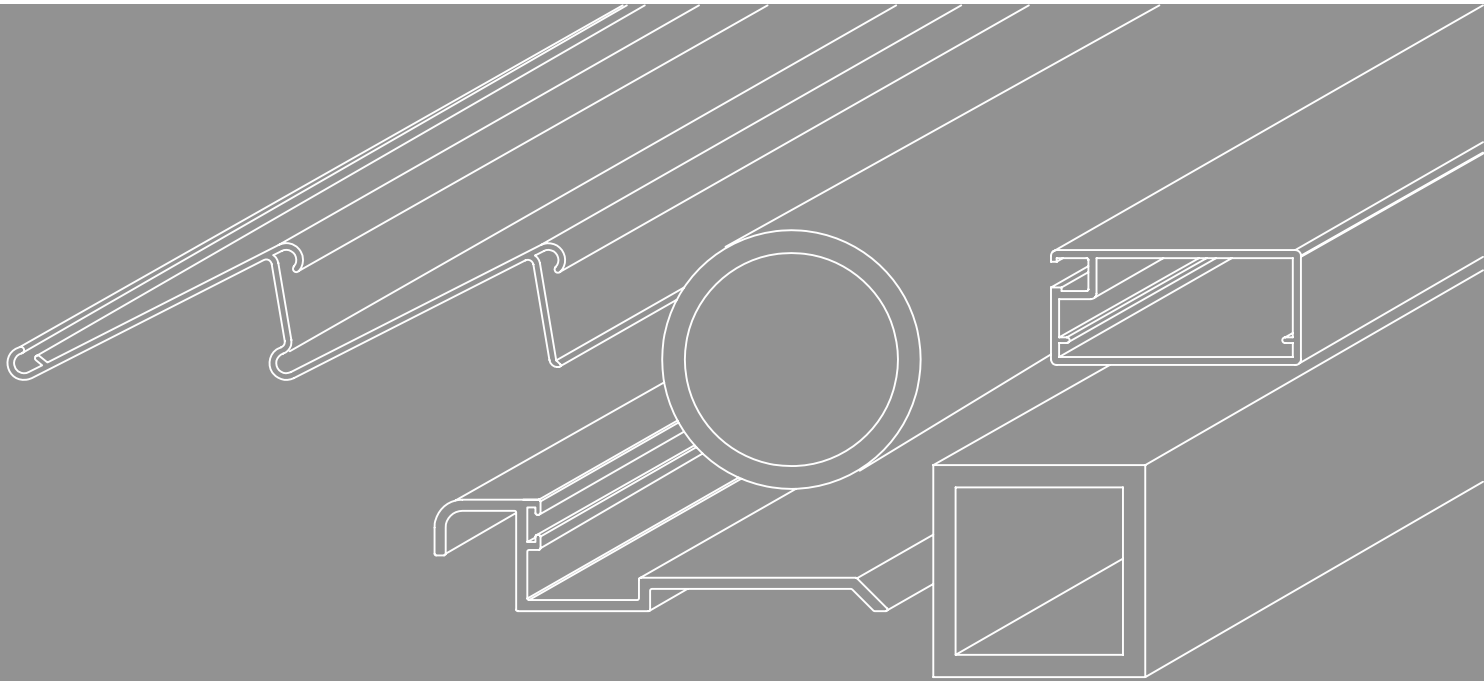

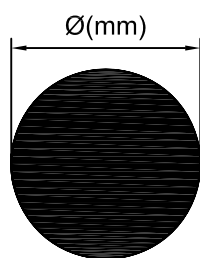
REDONDO MACIZO

Ø (mm)	REFERENCIAS	P. Teórico (kg/m)	Perímetro (m)
6	TS 1103023	0.080	0.02
6.5	TS 1103001	0.090	0.02
8	TS 1103005	0.143	0.03
12	TS 1103012	0.321	0.04
16	TS 1016066	Macizo Ø16 a 6.60m	
20	TS 102066	Macizo Ø20 a 6.60m	
25	TS 1103025	1.392	0.08
30	TS 1103030	2.00	0.10
40	TS 1103000	3.56	0.13
45	TS 1103000	4.51	0.14

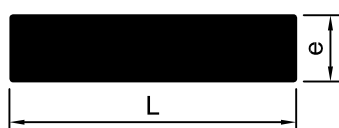
PLETINAS

L	e	REFERENCIAS	P. Teórico (kg/m)	Área Trat. (m)
13	3	TS 1102113	0.110	0.04
20	3	TS 1102100	0.170	0.05
20	4	TS 1102101	0.227	0.05
20	5	TS 1102102	0.284	0.05
25	10	TS 1102107	0.709	0.07
30	16	TS 1102108	1.36	0.09
40	20	TS 1102110	2.27	0.12
80	10	TS 1102114	2.27	0.18
100	10	TS 1102140	2.84	0.22
150	15	TS 1102160	6.38	0.33
47	14	TS 1023102	Pletina media caña c/ relieve	
55	15	TS 105515	Pletina media caña c/ relieve	
30	8	TS 10308	Pletina canteada	
40	8	TS 1023/01	Pletina canteada decorada	
40	8	TS 10408	Pletina canteada	

PERFIL "T"

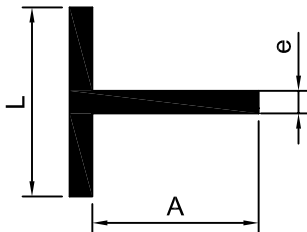

L	A	e	REFERENCIAS	P. Teórico (kg/m)	Área Trat. (m)
25	25	2	TS 1102400	0.284	0.10
30	30	2	TS 1102410	0.340	0.12
50	60	2	TS 1102420	0.612	0.22
100	60	2	TS 1102430	0.896	0.32

ANGULARES

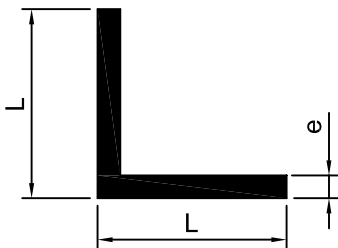

L	A	e	REFERENCIAS	P. Teórico (kg/m)	Área Trat. (m)
15	1.5	3	TS 1102200	0.12	0.06
15	1.1	3	TS 1102200/A	0.09	0.06
20	1.1	4	TS 1102201/A	0.12	0.08
25	1.5	5	TS 1102205	0.19	0.10
25	2	10	TS 1102206	0.26	0.10
30	1.5	16	TS 1102210	0.24	0.12
40	3	20	TS 1102220	0.626	0.16
50	3	10	TS 1102230	0.789	0.20
50	4	10	TS 1102234	1.04	0.20

TUBOS REDONDOS

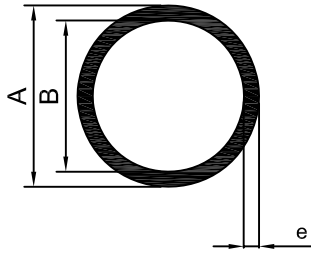

A Ø	B Ø	e	REFERENCIAS	P. Teórico (kg/m)	Área Trat. (m)
16	14	1	TS 1103104	0.134	0.05
16	13	1.5	TS 1103105	0.194	0.05
16	12	2	TS 1103106	0.249	0.05
19	17	1	TS 1103107	0.160	0.06
19.2	16.2	1.5	TS 1103108	0.236	0.06
24	20	2	TS 1103114	0.392	0.075
25	21	2	TS 1103115	0.409	0.079
30	27.5	1.25	TS 1103118	0.320	0.095
30	24	3	TS 1103118/A	0.721	0.095
45	39	3	TS 1103119	0.122	0.14
45	35	5	TS 1103119/A	1.781	0.14
50	46	2	TS 1103120	0.855	0.16
50	47	1.5	TS 1103120/A	0.648	0.16
60	56	2	TS 1103125	1.033	0.19
65	61	2	TS 1103130	1.122	0.20
65	57	4	TS 1103130/A	2.173	0.20

TUBOS CUADRADOS

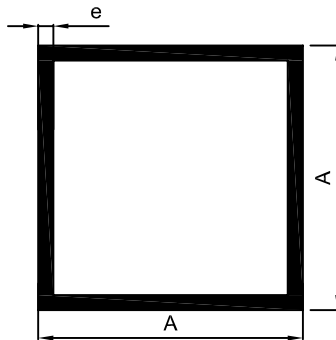

L	e	REFERENCIAS	P. Teórico (kg/m)	Área Trat. (m)
12	1.5	TS 1103201	0.180	0.05
15	1.5	TS 1103202	0.230	0.06
19.5	1.5	TS 1103204	0.305	0.078
20	2	TS 1103206	0.410	0.08
25	1.5	TS 1103208	0.400	0.10
25	1.1	TS 1103208/A	0.300	0.10
30	1.5	TS 1103210	0.485	0.12
30	2	TS 1103210/A	0.635	0.12
35	2	TS 1103212	0.750	0.14
35	1.1	TS 1103212/A	0.420	0.14
40	1.6	TS 1103215	0.700	0.16
40	2	TS 1103215/A	0.862	0.16
50	2	TS 1103220	1.090	0.20
50	3	TS 1103221	1.590	0.20
65	1.5	TS 1103225	1.080	0.26
75	1.5	TS 1103230	1.250	0.30
85	2	TS 1103240	1.880	0.34
100	2	TS 1103250	2.222	0.40

CUADRADO MACIZO

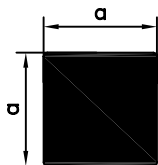

L	REFERENCIAS	P. Teórico (kg/m)	Área Trat. (m)
15	TS 1102001	0.640	0.06
16	TS 101616	∅ 16 a 6.60 m	
20	TS 102020	∅ 20 a 6.60 m	
23.4	TS 2060	1.552	0.09

TUBOS RECTANGULARES

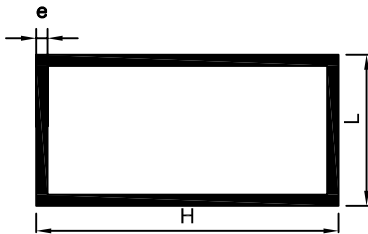

L	A	e	REFERENCIAS	P. Teórico (kg/m)	Área Trat. (m)
15	30	1.5	TS 1103305	0.357	0.09
20	40	1.5	TS 1103310	0.485	0.12
20	40	2	TS 1103311	0.634	0.12
20	50	1.5	TS 1103314	0.570	0.14
20	60	2	TS 1103313	0.859	0.16
20	70	1.5	TS 1103315	0.740	0.18
25	50	2	TS 1103316	0.805	0.15
25	50	1.5	TS 1103317	0.612	0.15
30	60	2	TS 1103318	0.975	0.18
40	75	1.5	TS 1103325	0.953	0.23
50	80	3	TS 1103327	2.10	0.26
45	100	2	TS 1103330	1.60	0.29
50	100	3	TS 1103333	2.45	0.30
25	150	2	TS 1103340	1.94	0.35

REGLAS

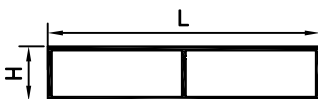

L	A	e	REFERENCIAS	P. Teórico (kg/m)	Área Trat. (m)
100	20	1.5	TS 1102011	1.07	0.24
120	25	1.4	TS 1102035	1.217	0.29

04

ACCESORIOS CANCELAS

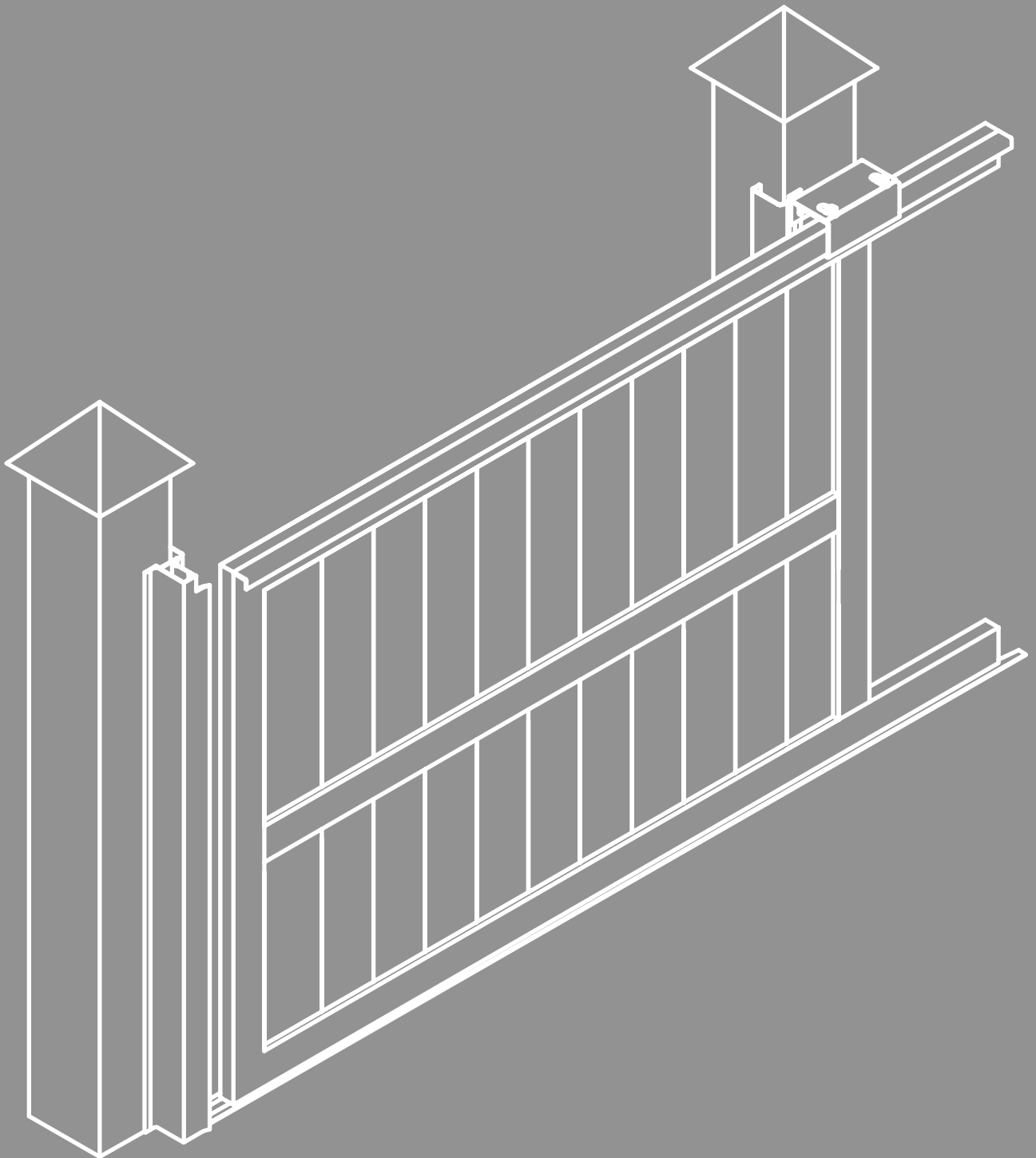

ACCESORIOS CANCELA ABATIBLE

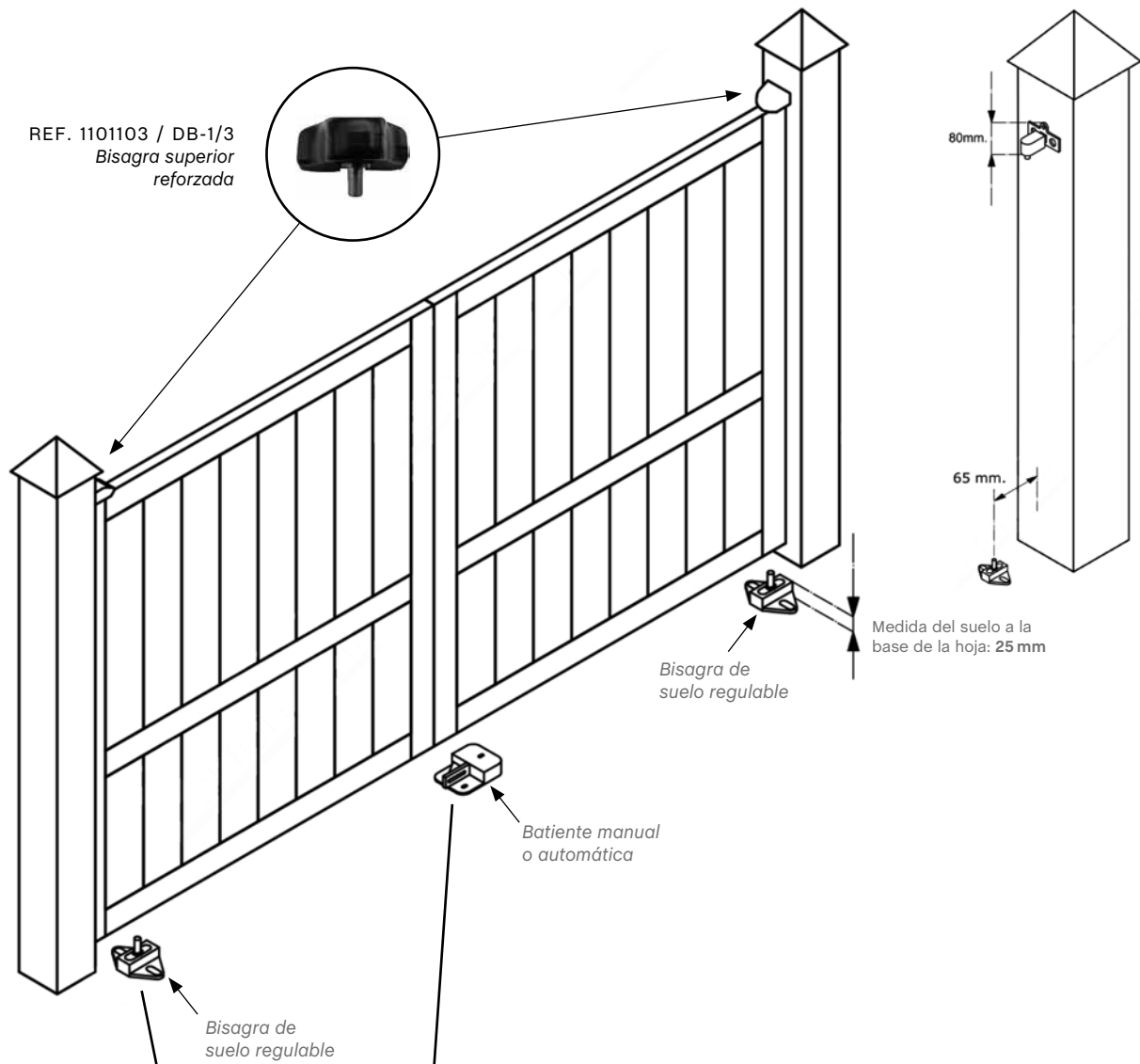

REF. 1101105 / DB-5
Bisagra de suelo eje latón con bola INOX



REF. 50191 / DB-7
Tope batiente 2 hojas



REF. 1101102 / TF-2
Tapa fundición con casquillo para bisagra de giro



REF. 1101104 / DB-2/4
Bisagra superior/inferior regulable

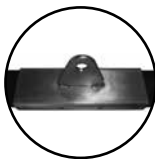

REF. 110508 / 02-6526/27
Soporte fijación a brazo motor



REF. 110333 / TF-3
Tapa fundición marco

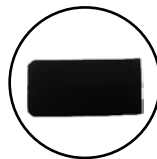

REF. 1101101 / TF-1
Tapa fundición hoja grande

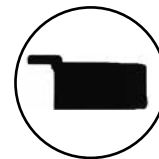

REF. 110444 / TF-4
Tapa fundición hoja batiente

ACCESORIOS CANCELA CORREDERA

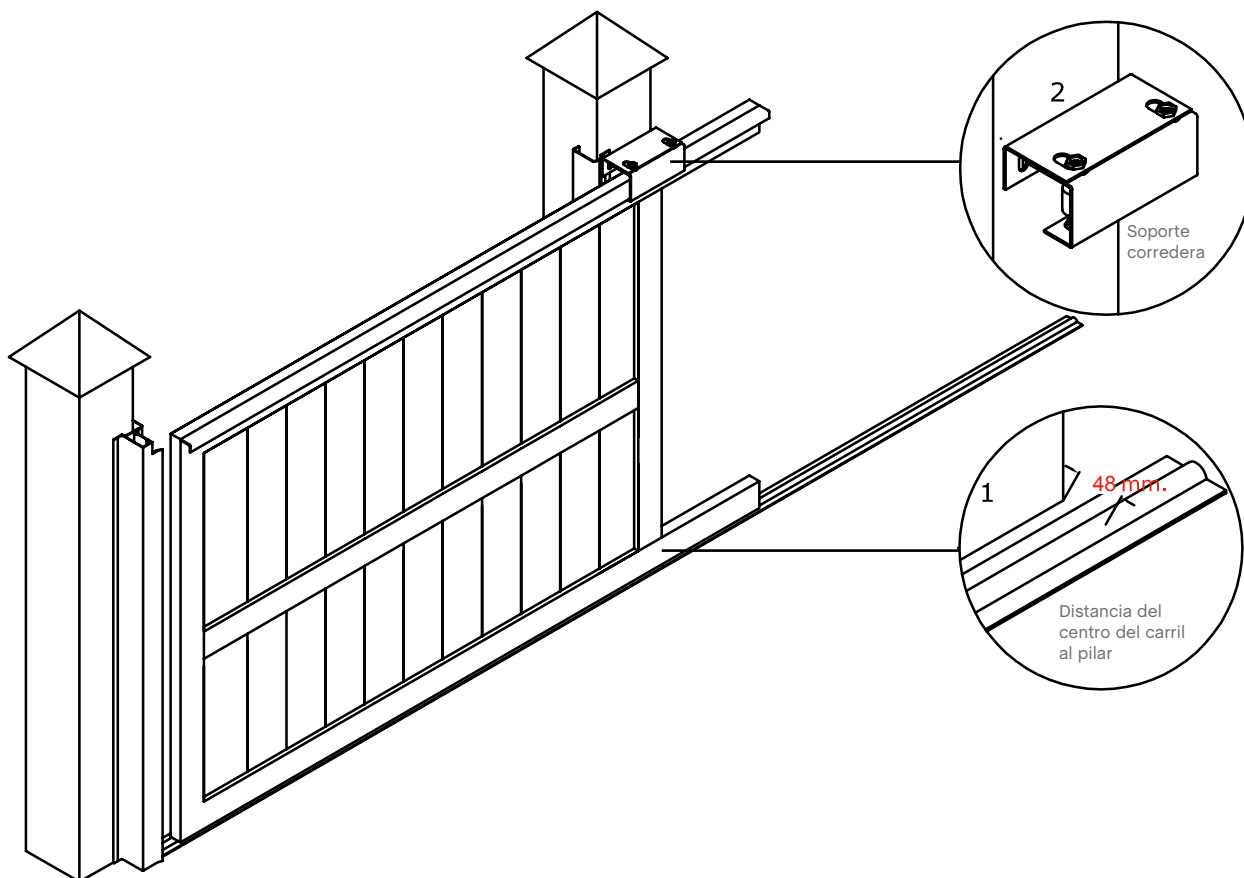

REF. 50465011 / 02-06524/25
Soporte corredera con rodillos



REF. 50666
Cerradura de gancho



REF. 50310800
Polea Nylon 80mm
Soporte atornillar



REF. 5004710383
Tope final

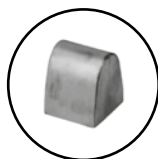

REF. 10812
Centrador corredera



REF. 1106528 / 02-06528
-

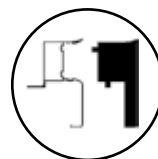

REF. 1106529 / 02-06529
Tapas para batiente de cierre

ACCESORIOS CANCELAS

DISEÑO	DESCRIPCIÓN	REFERENCIA
	Clavos decorativos aluminio <i>Puede ser con rosca M-8 o con varilla de 30 y 50 mm</i>	REF. 10122 REF. 10858
	Tapa decorativa lama tablón biselada	REF. 1020025
	Manilla inox	REF. 5010
	Manillón inox recto Ø	REF. 810300300
	Manillón inox desviado	REF. 810300301
	Centrador puerta corredera	REF. 10812040 para T40 REF. 10812050 para T50
	Polea nailon 80 soporte atornillar <i>Para Ø20 mm</i> <i>* Todas las medidas</i>	REF. 50310803002 REF. 503108002050
	Tope corredera atornillar	REF. 5004710383

ACCESORIOS CANCELAS

DISEÑO	DESCRIPCIÓN	REFERENCIA
	Tope puerta batiente aluminio <i>Medidas 32x125x110 mm</i>	REF. 50191
	Tope puerta batiente con gomas <i>Medidas 32x125x110 mm</i>	REF. 50831
	Rodillos nailon <i>Medidas 30x40 mm</i> <i>* Todas las medidas</i>	REF. 50046030 REF. 500460300500
	Soporte superior 2 rodillos corredera <i>Medidas 165x70 mm</i>	REF. 5000464
	Soporte superior 4 rodillos corredera <i>Medidas 220 mm</i>	REF. 50465220 REF. 504652205
	Manillón aluminio rústico Diabolo <i>Medidas 360x38 mm</i>	REF. 820030
	Juego manilla recuperable aluminio	REF. 6204459
	Cerradura corredera gancho. <i>Medidas para t-60, t-70, t-80 y t-100</i>	REF. 50666







ACCESORIOS CANCELAS

DISEÑO	DESCRIPCIÓN	REFERENCIA
	Cerradura eléctrica CISA <i>Con o sin botón</i>	REF. 60731 C/B REF. 60721 S/B
	Cerradura embutir puerta peatonal <i>Medidas para entrada de 20, 23, 25, 28, 30, 33 y 38</i>	REF. 6074023
	Portero eléctrico <i>Corto y largo</i>	REF. 6078
	Carril sobreponer <i>Medidas 3.000 mm</i> <i>* Disponible Inox</i>	REF. 5036901 REF. 5036905
	Carril sobreponer V <i>Medidas 3.000 mm</i> <i>* Disponible Inox</i>	REF. 50370
	Carril empotrar V <i>Medidas 3.000 mm</i> <i>* Disponible Inox</i>	REF. 50365 REF. 5036505
	Tope/Escuadra unión hoja <i>Medidas 75,5x30,8 mm</i>	REF. 1105 (en barra) REF. 110501 (en pieza)
	Soporte inferior con vástago bronce <i>Medidas 43x117x44 mm</i>	REF. 110110501

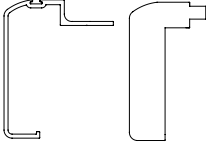
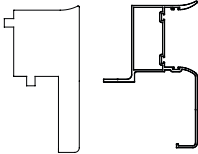
ACCESORIOS CANCELAS

DISEÑO	DESCRIPCIÓN	REFERENCIA
	Soporte inferior vástago con bola <i>Medidas 43x117x44 mm</i>	REF. 1101105
	Tope batiente con retenedor <i>Medidas 43x180x113 mm</i>	REF. 10786
	Bisagra superior/inferior regulable <i>Medidas 132x86x44 mm</i>	REF. 1101104
	Bisagra superior regulable <i>Medidas 72x95x126 mm</i>	REF. 1101103
	Tapa superior perfil batiente / corredera cierre	-
	Tapa bisagra superior/inferior con casquillo de bronce	REF. 1101102 / TF-2
	Soporte superior corredera aluminio	REF. 50465011
	Tapa lisa hoja grande	REF. 1101101 / TF-1

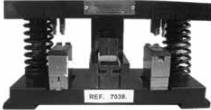
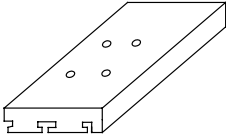
ACCESORIOS CANCELAS

DISEÑO	DESCRIPCIÓN	REFERENCIA
	Tapa superior perfil remate final corredera	REF. 1106528 / CÓD. 6528
	Tapa superior perfil remate final corredera	REF. 1106529 / CÓD. 6529
	Tapa fundición marco pequeño izquierdo y derecho	REF. 110333 / CÓD. TF-3
	Escuadra de expansión	REF. 110888 / CÓD. 888
	Tapa fundición hoja con batiente izquierdo y derecho	REF. 110444 / CÓD. TF-4
	Troquel hoja	REF. 110507
	Plantilla mecanización hoja para tope escuadra	REF. 110505
	Soporte fijación motor inox puerta batiente	REF. 110508
	Juego de fresas mecanización hoja	-

05

HOJAS DE CORTE

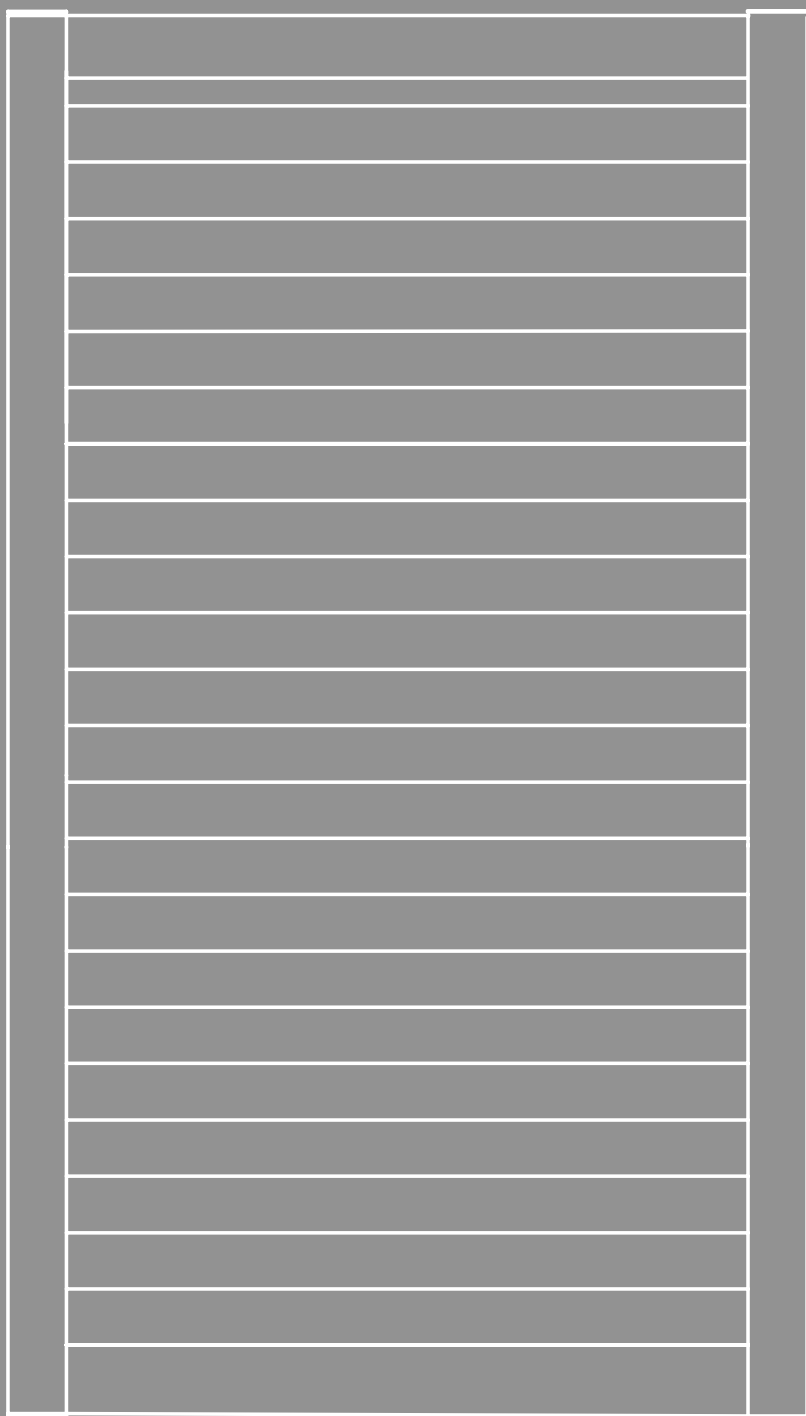

PUERTA ABATIBLE 1 HOJA

PUERTA ABATIBLE 1 HOJA





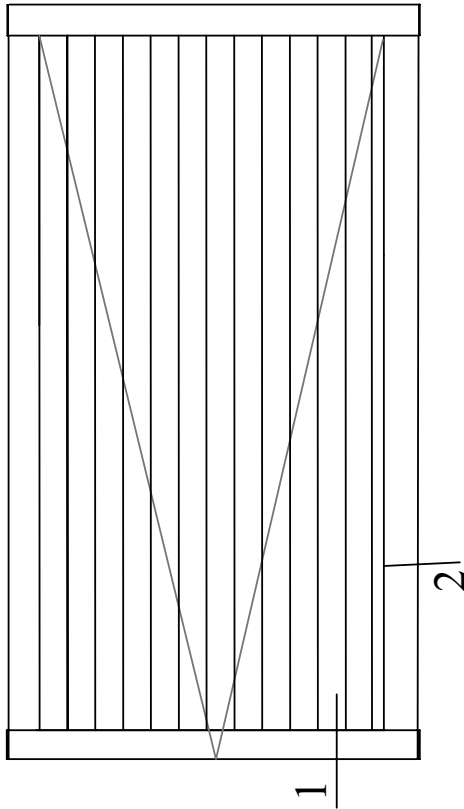

LAMA VENTILADA 90 mm

BISAGRAS DE GIRO REGULABLES



(1)

L = Ancho entre pilares
H = Altura desde el suelo.

Perfil	Ref.	Descripción	Corte Uds	Medidas
	APT 002	Hoja	Horizontal (2) Vertical (2)	L - 230 H - 35
	APT 005	Bisagras Remate Decorativo	Vertical (1)	H
	TP 010	Lama ventilada 90x40	Horizontal	L - 283
	APT003	Marco	Vertical (1)	H
	APT 008	Tapa Remate Hoja	Horizontal (2) Vertical (2)	L - 283 H - 35
	APT007	Perfil U Remate	Horizontal (2) Vertical (2)	L - 239 H - 258

Sección 1

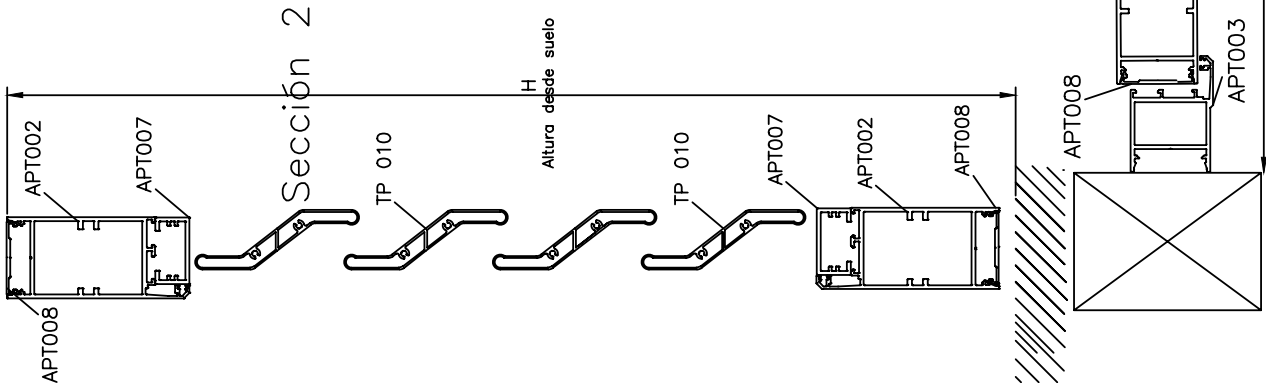

L Ancho entre Pilares



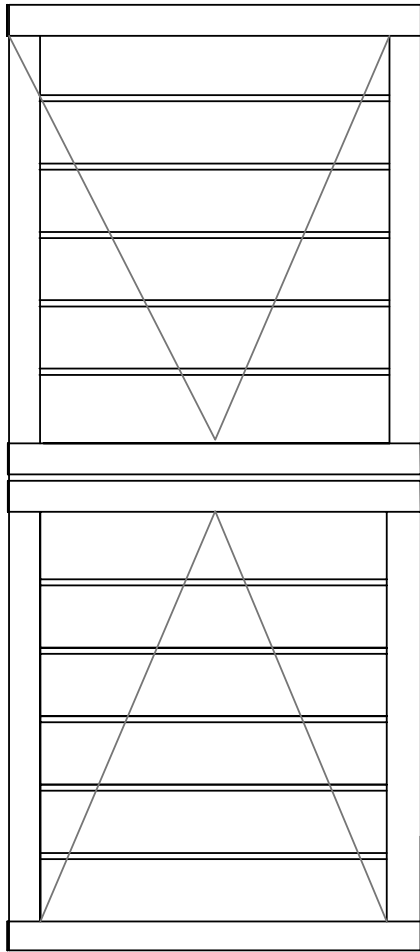

PUERTA ABATIBLE 2 HOJAS

PUERTA ABATIBLE 2 HOJAS

LAMA 200 X 20 mm Biselada
BISAGRAS DE GIRO REGULABLES

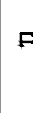

L = Ancho entre pilares
H = Altura desde el suelo.

Perfil	Ref.	Descripción	Corte Uds	Medidas
	APT 002	Hoja	Horizontal (4) Vertical (4)	L / 2 - 214 H - 35
	APT 005	Baifiente Central 2H Baifiente Remate Decorativo	Vertical (2) Vertical (2)	H - 35 H
	APT 030	Lama 200 x 20 mm	Vertical	H-218
	APT 008	Tapa Remate Hoja	Horizontal (4) Vertical (2)	L / 2 - 266 H-35
	APT 017	Junquillo 17 mm	Horizontal (4) Vertical (4)	L / 2 - 222 H-258

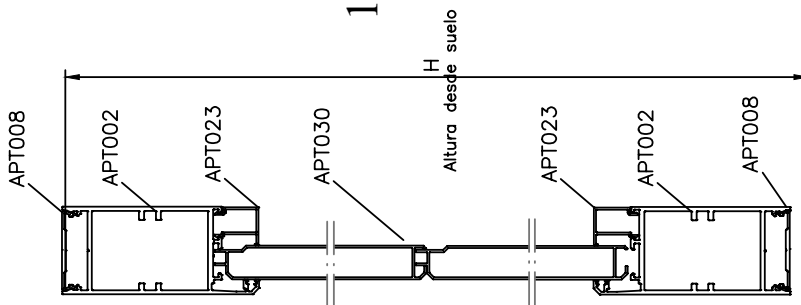

Sección 2

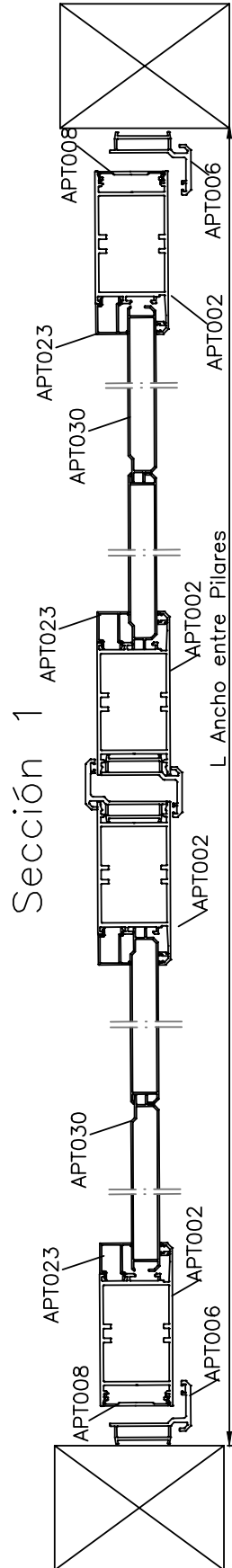







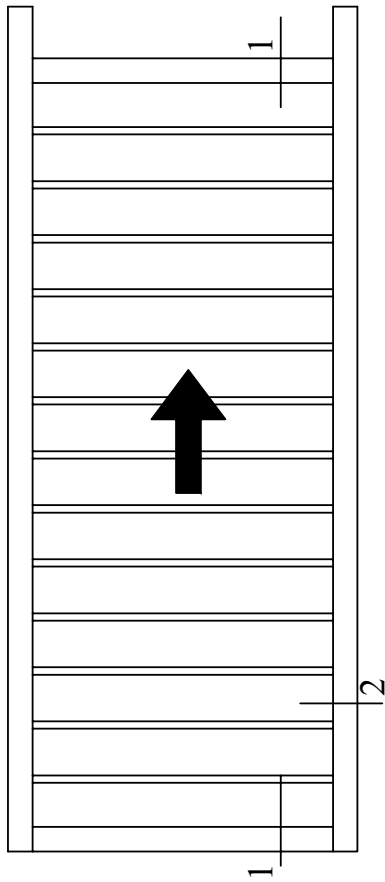

Sección 1

L Ancho entre Pilares

PUERTA CORREDERA

PUERTA CORREDERA
LAMA 200 mm UNION CON TUBO



Perfil	Ref.	Descripción	Corte Uds	Medidas
	APT 002	Hoja Horizontal	(2)	L+17+(Cola 250/300mm)
	APT 012	Hoja Vertical	(2)	H - 200
	APT 032	Guía Superior	(1)	L+17+(Cola 250/300mm)
	APT 008	Lama Bisel de Tubo Tubo Rectangular 50x20	(2)	H - 213
	APT 010	Tapa Remate Hoja	(2)	H-254
	APT 011	Batiente de cierre Corredera	(1)	H + 5
	APT 017	Remate paso Corredera	(1)	H + 5
	APT 017	Junquillo 17 mm	(2)	L - 171
			(1)	H - 253

L = Ancho entre pilares
H = Altura desde el suelo.

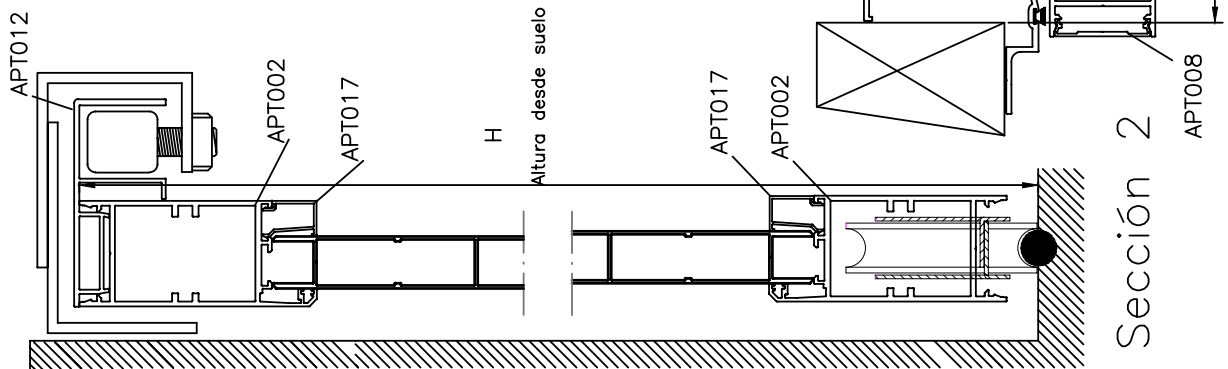









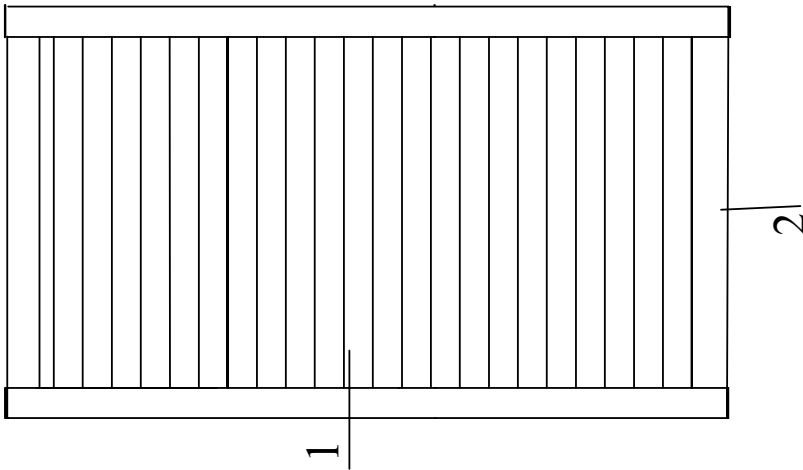





PUERTA DE PASO PEATONAL

PUERTA DE PASO PEATONAL

LAMA 100 X 20 mm

BISAGRAS CANAL EUROPEO



Perfil	Ref.	Descripción	Corte Uds	Medidas
	APT 002	Hoja	Horizontal (2)  Vertical (2) 	L - 317,5 H - 35
	APT 005	Bisagra Canal Europeo	Vertical (2) 	H - 35
	TP 010	Lama 100 x 20 biselada	Horizontal 	L - 330
	APT001	Marco	Vertical (2) 	H - 5
	APT 008	Tapa Remate Hoja	Horizontal (2) 	L - 370
	APT023	Junquillo 23 mm	Horizontal (2)  Vertical (2) 	L - 326 H - 258

L = Ancho entre pilares

H = Altura desde el suelo.

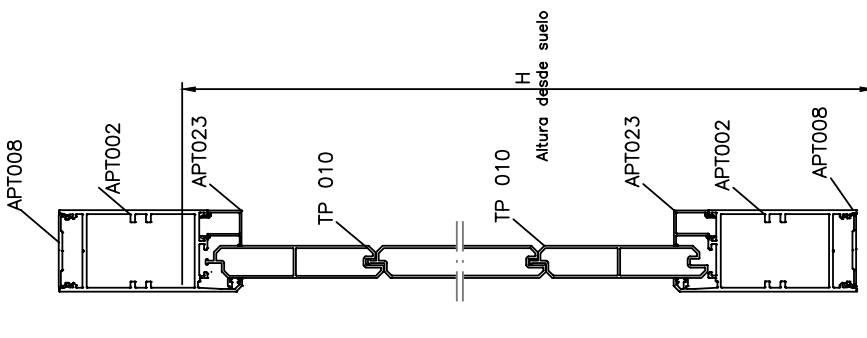

Sección 2

Sección 1

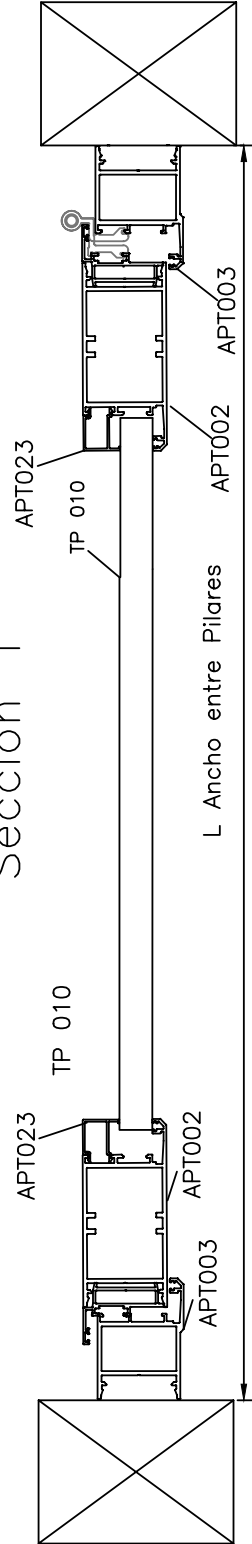

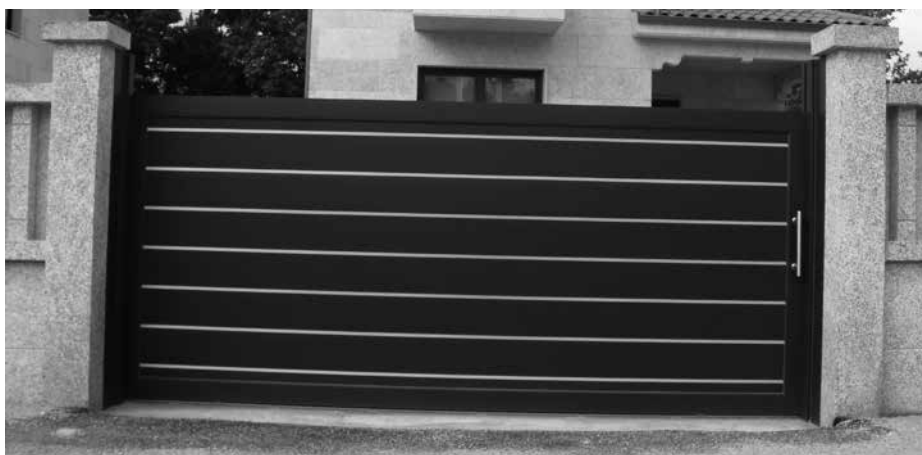

Ver páginas 38-39 para montaje.



Ver páginas 38-39 para montaje.



Suministros Cerrajeros Miño
SUCERMIÑO, S.L.

Polígono Barreiros C/C - Nave 17
32915 San Cibrao das Viñas - Ourense (España)
Tel.: +34 988 24 83 77 · Fax: +34 988 26 96 45
E-mail: suministroscerrajeros@yahoo.es